

DuraVane oil-free rotary vane compressors are heavy-duty compact motor-mounted units, extremely reliable for many industrial applications. Efficient cooling is ensured by a powerful centrifugal fan.

- Fewer vanes than other oil-free rotary vane compressors.
- High-tech, self-lubricating graphite composite vane material.
- Longer vane life and less vane replacement.
- Heavy-duty construction.
- Compact design, small footprint.
- Low noise level.
- Air-cooled design.
- Direct drive.
- Simple to install.



Performance characteristics

Displacement: 53CFM
 Max. Pressure: 5.8/13.2psig
 Motor: 4.0/5.0HP/60HzTEFC
 Voltage: 208/230/460V/3phase
 Speed: 1800RPM
 Noise level(at 3ft): 74dBA
 Weight: 162Lbs
 Inlet conn.: 1"NPT
 Discharge conn.: 1"NPT

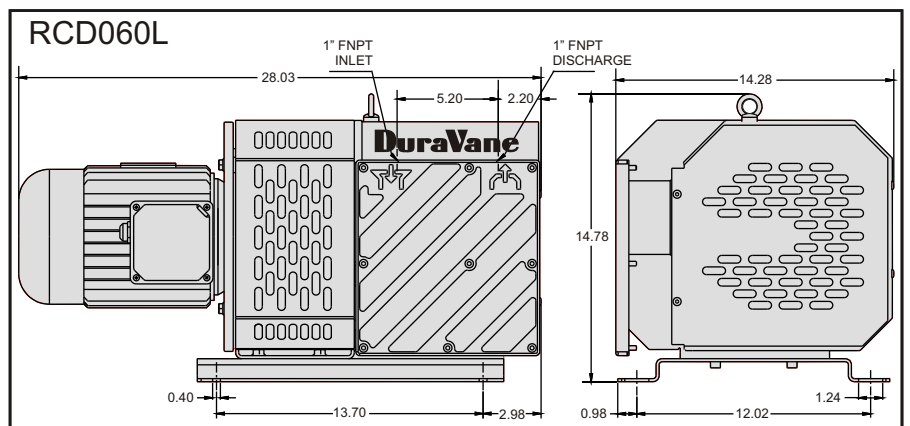
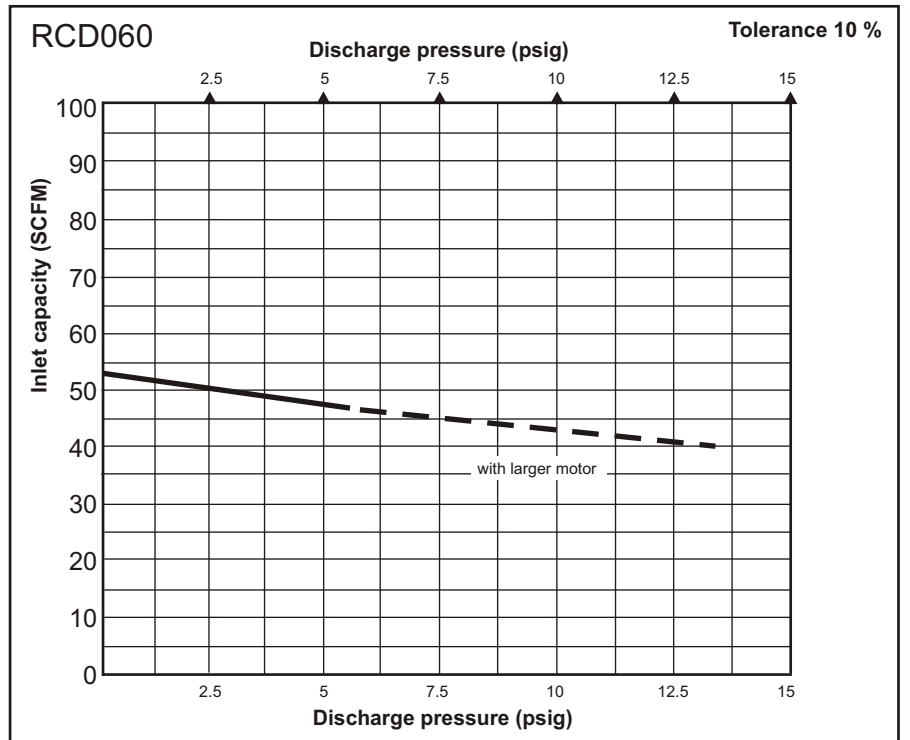

Information contained in this document is for reference only. Subject to change without notice.