

Introducing the **MAXIMA-K** 3K series maximum efficiency, single-stage liquid ring vacuum pump.

- ◆ Reliable heavy-duty design, built to rigid quality standards.
- ◆ Variable discharge port enables pumps to operate at maximum efficiency over the entire vacuum range.
- ◆ Shaft sleeves are standard, virtually eliminating the possibility of shaft wear.
- ◆ Available in different materials to suit your application.
- ◆ Standard sealing is packed gland, mechanical seals available.
- ◆ Heavy duty bearings mounted external to the pumping chamber, eliminating potential bearing failure due to process contamination.
- ◆ Low operating speeds ensure an extended life cycle.
- ◆ The pump can handle large amounts of condensable vapors which enhances the performance significantly.
- ◆ No metal-to-metal contact, only one moving part.
- ◆ The pumps can handle carry-over of liquids and/or soft solids without causing damage to the internal parts.
- ◆ The design allows operation with various seal fluids.
- ◆ Low operating noise levels are in the 75 - 85 dBA range.



Performance characteristics

Nominal capacity:	1500-2250CFM
Motor range:	75-150HP
Speed range:	500-740RPM
Maximum vacuum:	29"Hg/26Torr
Weight (bare-shaft):	3080Lbs/1400kg
Maximum gas inlet temp.:	212°F/100°C
Noise level(at 3ft):	75-85 dBA

Materials of construction/Seal code

Mat.code	3	4**	7*	8*	11	14
Casing	CI	316SS	NA	CI	CI	304SS
Portplate	CI	316SS	NA	CS	CI	304SS
Impeller	316SS	316SS	NA	DI	304SS	304SS
Shaft	CS	316SS	NA	CS	420SS	304SS
Seal code	P***	P***	P***	P***	P***	P***

CI = cast iron - DI = ductile iron - CS = carbon steel
304SS = AISI 304 stainless steel - **316SS** = AISI 316 stainless steel - **420SS** = AISI 420 stainless steel
 * standard material pumps protected by 420 SS shaft sleeves.
 ** 316 SS pumps protected by 316 SS shaft sleeves
 *** P = standard seal is packed gland, other seal materials available.
 Other materials and special coatings available upon request.

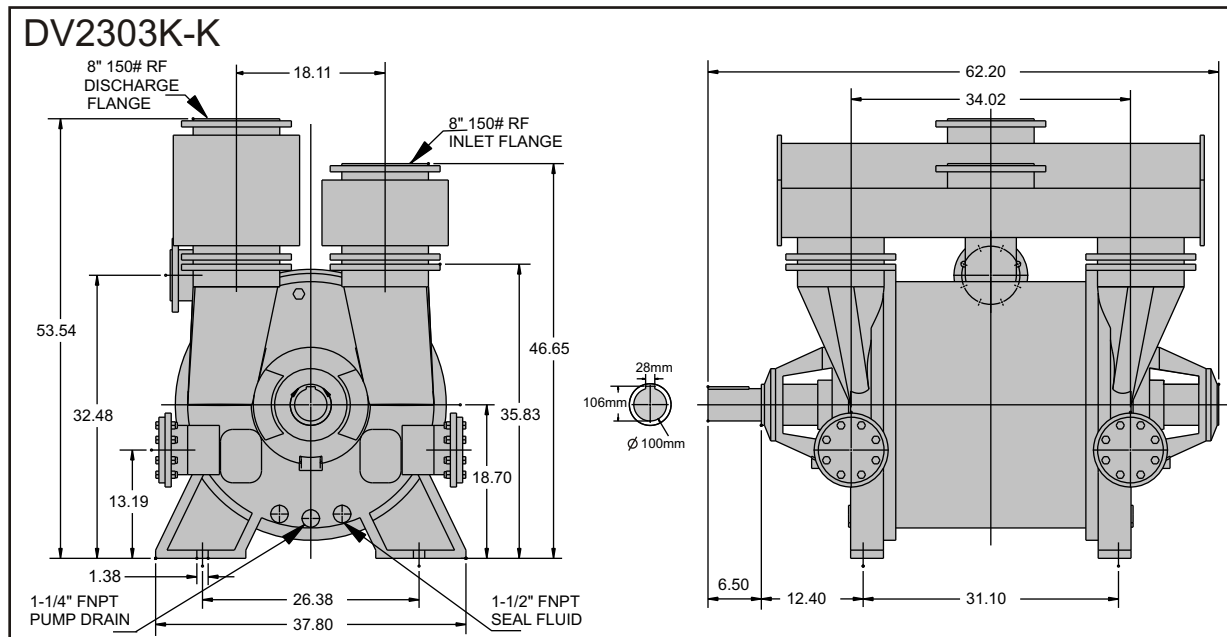

Performance charts see next page

Dimensions (inches) not binding. Subject to change without notice. Inlet manifold, discharge separator and companion flanges are sold separately.

