



**DEKKER**  
**VACUUM TECHNOLOGIES, INC.**

Installation  
Operation  
&  
Maintenance  
Manual

**DuraVane**

Oil-Free (Dry) Rotary Vane Vacuum Pump Systems

# **DuraVane**

*OIL-FREE (DRY) ROTARY VANE VACUUM PUMP SYSTEMS*  
**TABLE OF CONTENTS**

<b>CUSTOMER SERVICE</b>	<b>5</b>
CONTACT INFORMATION	5
ORDER INFORMATION	5
<b>INTRODUCTION</b>	<b>6</b>
<b>SAFETY</b>	<b>6</b>
<b>THEORY OF OPERATION</b>	<b>7</b>
<b>STORAGE</b>	<b>7</b>
<b>INITIAL FREIGHT RECEIPT AND INSPECTION</b>	<b>7</b>
<b>INSTALLATION</b>	<b>7</b>
OVERVIEW	7
UNPACKING	7
LIFTING	8
LOCATION	8
MOUNTING	8
VENTILATION	8
ELECTRICAL PREPARATION	9
PIPE CONNECTION AND SIZING	9
INLET PIPING	9
<b>START-UP PROCEDURES</b>	<b>11</b>
<b>SHUT DOWN PROCEDURES</b>	<b>11</b>
<b>MAINTENANCE</b>	<b>11</b>
PUMP BEARING LUBRICATION	11
MOTOR BEARING LUBRICATION (WHERE REQUIRED)	11
VANES	12
<b>MAINTENANCE SCHEDULE</b>	<b>12</b>
FIRST 8 HOURS OF OPERATION	12
500 HOURS OF OPERATION	12
1000 HOURS OF OPERATION	12
2500 HOURS OF OPERATION	12
4000 HOURS OF OPERATION	12
6000 HOURS OF OPERATION	12
10,000 HOURS OF OPERATION	12

30,000 HOURS OF OPERATION	13
<b>ACCESSORIES (IF INCLUDED)</b>	<b>13</b>
<b>TROUBLESHOOTING</b>	<b>13</b>
START-STOP PROBLEMS	13
UNIT WILL NOT START	13
UNIT STARTS, BUT HAS DIFFICULTY DOING SO, AND DRAWS A HIGH CURRENT	14
VACUUM PROBLEMS	14
UNIT IS NOT DRAWING VACUUM	14
UNIT IS NOT REACHING ULTIMATE VACUUM LEVEL	14
OVERHEATING PROBLEMS	15
UNIT IS OVERHEATING	15
NOISE AND VIBRATION PROBLEMS	15
THE UNIT IS MAKING AN ABNORMAL NOISE OR SOUND	15
TROUBLESHOOTING QUICK REFERENCE GUIDE	16



**THIS INSTALLATION, OPERATION, AND  
MAINTENANCE MANUAL MUST STAY WITH  
EQUIPMENT.**

**PLEASE REGISTER YOUR EQUIPMENT  
WARRANTY AND START-UP RECORD ONLINE  
AT WWW.DEKKERVACUUM.COM**

## **CUSTOMER SERVICE**

### **Contact information**



935 SOUTH WOODLAND AVENUE, MICHIGAN CITY, IN 46360-5672

TEL.: 219-861-0661 – FAX: 219-861-0662 – TOLL-FREE: 888-925-5444

Bus. Hours: 7:30 a.m. – 4:30 p.m. CST

Website: [www.DEKKERvacuum.com](http://www.DEKKERvacuum.com)

### **Order Information**

When calling for service, parts or system information always have the pump or system model number and serial number(s) ready. Refer to the bill of lading or the gold-colored system information plate attached to the system (see image below).

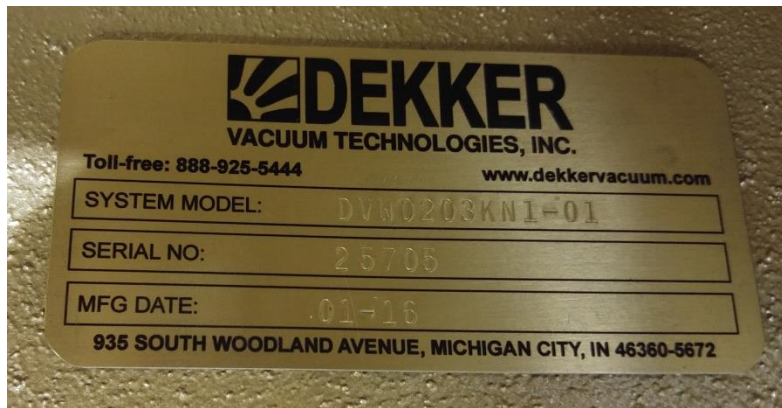

*Gold-colored system information plate*

Parts should be purchased from the nearest authorized DEKKER Vacuum Technologies, Inc. (hereafter referred to as DEKKER) representative (visit [www.dekkervacuum.com](http://www.dekkervacuum.com) to find a distributor near you via the [Distributor Locator](#)) or from the vacuum pump system supplier. If, for any reason parts, cannot be obtained in this manner, contact the factory directly.

## **INTRODUCTION**

The DuraVane rotary vane vacuum pumps have been designed to give you safe, reliable and trouble-free service, provided the basic maintenance guidelines as set out in this manual are followed. A vacuum pump is a rotating piece of equipment and operators must exercise good judgment and follow proper safety procedures to avoid damage to the equipment or personal injury. Please review and follow all instructions in this manual before attempting to install, start, or operate equipment.

## **SAFETY**

All vacuum pumps, systems and/or compressors (hereafter referred to as the Product) offered by DEKKER have been designed and manufactured for safe operation. However, the responsibility for safe operation rests with those who use and maintain these products. The safety department where the product is installed should establish a safety program based on OSHA, federal, state, and local codes. It is important that due consideration be given to hazards which arise from the presence of electrical power, hot liquids, harmful gases, and rotating equipment. Proper installation and care of protective devices is essential to safe system operation. These safety procedures are to be used in conjunction with the instructions contained in this manual.



**WARNING: DO NOT PUMP OXYGEN or oxygen rich mixtures with these pumps -  
EXPLOSION HAZARDS!**

## **THEORY OF OPERATION**

The DEKKER DuraVane non-lubricated rotary vane pump systems are single-stage air-cooled units with no internal lubrication. The vacuum pump works by using centrifugal force to turn vanes against the surface of a cylinder causing pockets of air to be pushed from the inlet to the discharge as air pressure increases. These pumps can operate with closed suction without overheating.

The construction is heavy-duty and compact, resulting in a small footprint. The high-tech vane material provides extended vane life.

## **STORAGE**

Keep the pump in a cool, dry environment and plug all open ports to keep out dirt and foreign objects.

## **INITIAL FREIGHT RECEIPT AND INSPECTION**

Before a system ships from DEKKER, it is thoroughly tested, and will not be released unless it passes our Quality Control standards. All pumps are thoroughly inspected and are not released unless they pass our Quality Control standards. Once the product is received and signed for in Good Condition, DEKKER cannot be held accountable for undiscovered, unclaimed damage that is a result of freight transit. It is the responsibility of the receiver to thoroughly inspect and test the product for functionality upon delivery. The customer should take photos of the product as it arrives and send to DEKKER and the freight carrier if there are any issues. The party who selected the shipper is responsible for filing the freight claim. Failure to report these issues within the freight carriers' undiscovered damage window can result in non-acceptance of freight claims. DEKKER does keep photos of all systems, as shipped, to assist in freight claims. Report any damage immediately to the factory.

Key items to inspect:

- Is the product received as requested? Are all parts, accessories, and components delivered?
- Was the skid or crating received in good condition? Check for cosmetic damage.
- Check wiring inside of control panel. Are all wires should be terminated and connections tight? (If applicable)
- Check control panel components. Are they tight on DIN rail and/or other mounts/fasteners?
- Are there any leaks or puddles around the pump? Specify hose, piping or housing leak.

System must be given an initial startup test as soon as possible after delivery. This is to ensure that the motor has not shifted out of alignment during transit as well as to verify that electrical components are functioning without fault – Variable Frequency Drive (VFD), Programmable Logic Controllers (PLC), panel cooling fans, transducers.

## **INSTALLATION**

### **Overview**

The design of the piping system, foundation layout, and plant location are the responsibility of the purchaser. DEKKER Vacuum Technologies, Inc. and its representatives may offer advice, but cannot assume responsibility for operation and installation design.

Please consult the factory or a specialist skilled in the design of plant layout, system piping design, and foundation design. The installer should carefully read this manual before installing the equipment. DEKKER or the factory can provide start up assistance in most instances for a fee. Contact DEKKER for hourly/daily service rates.

### **Unpacking**

Upon receipt of pump or system, immediately inspect for signs of damage. Carefully remove packing or crating from around pump or system. Be sure to keep equipment in upright position.

## Lifting

Lift the equipment carefully and with weight evenly distributed. DEKKER is not responsible for equipment that has been damaged through mishandling or dropping.

## Location

Install the unit in a well ventilated and dust free area. The pump or system should be a minimum distance of 3 feet from surrounding walls to allow for checking fluid level, temperatures, pressures and general servicing.

## Mounting

The pump or system must be installed on a level surface in the horizontal position. The foundation must be designed to support the total unit weight, without any settlement or crushing, be rigid and substantial enough to absorb any equipment vibration, maintain true alignment with any drive mechanism, and must permanently support the system baseplate at all points. The vacuum system must be leveled and secured with anchor bolts. Anchor bolts must be of adequate size to withstand the mechanical stresses exerted on it.

Systems 50 HP and larger should also be grouted into position per local codes. The foundation should be constructed to allow for  $\frac{3}{4}$  to 1- $\frac{1}{2}$  inch of grout. The baseplate is set on shims and the grout is poured between the foundation and the baseplate. To have the required body to support the baseplate, grout should be at least  $\frac{3}{4}$  inch thick.

The number and location of shims will be determined by the design of the baseplate. Firm support should be provided at points where weight will be concentrated and at the anchor bolt locations. Use enough, and large enough, shims to provide rigid support. Baseplates are usually designed with openings to allow pouring grout. When the baseplate has been shimmed, leveled, and the anchor bolts have been snugly tightened, a dam is constructed around the foundation to contain the grout. The dam level should be at least  $\frac{1}{2}$  inch above the top surface of the shims. Grout should be poured inside and around the outside of the baseplate and leveled. Allow the grout to dry for a minimum of 48 hours before tightening the anchor bolts.

**Please note** that the pump/motor coupling and V-belt units will need to be realigned prior to start-up, with the exception of monoblock units.

## Ventilation

Locate the unit in an area with sufficient airflow and accessibility. To prevent excessive ambient temperature rise it, is imperative to provide adequate ventilation. Cooling is an important aspect of reliable equipment operation and it is therefore important to install the unit in a reasonably cool area where the temperature does not exceed 104°F (40°C). For higher ambient temperatures contact the factory.



## Electrical Preparation

All system wiring is performed at the factory if a control panel is supplied and installed on the skid. Check area classification to ensure all electrical enclosures comply with code. Required customer wiring is minimal, but should be done by a qualified electrician in compliance with OSHA, National Electric Code and any other applicable local electrical code concerning switches, fused disconnects, etc. DEKKER includes a wiring diagram in the control panel for use by the installer. DEKKER recommends a main disconnect switch be fitted between the vacuum system and the incoming power.

After the electrical wiring connections are completed, check the incoming voltage to make sure the incoming voltage is the same as the vacuum system voltage. Line voltage should be within the voltage tolerance as specified on the motor or to local code. Check the system for proper motor rotation. The direction of rotation is marked by an arrow on the motor or pump housing. Jog the motor by pressing the ON button and then the OFF button. If the rotation is incorrect, switch any two of the three main power leads (three phase power) on the contactor inside the control panel. Failure to do so could result in serious equipment damage.



**WARNING: Install, ground, and maintain equipment in accordance with the National Electrical Code and all applicable federal, state and local codes.**

## Pipe Connection and Sizing

Before installation, remove all protective inserts on the pump suction and discharge. Piping connected to the system must be installed without imposing any strain on the system components. Improperly installed piping can result in misalignment, general operating problems and pump failure. Use flexible connectors where necessary. Piping must be cleaned of debris before installation.

The piping system has to be designed to ensure that no liquids carried over from the process can reach the pump. If this possibility exists, a knock-out liquid separator should be installed. Consult the factory for recommendation.

## Inlet Piping

**Note:** Install a temporary screen at the pump inlet flange at first start-up to protect the unit against carryover of pipe debris and welding slag. The screen must be removed after the initial run-in period.

Inlet piping should be at least the size of the pump inlet and rated for vacuum service. Install the unit as close as possible to the process to minimize losses due to the length of the suction line. If the unit has to be installed further away from the process, be sure that the inlet piping is oversized accordingly to minimize the overall line pressure drop.

All DuraVane pumps operating in parallel on a common manifold or receiver should each have a manual or automatic shut-off valve and a suitable check valve installed in the suction line close to the pump suction flange. This allows each individual pump to be isolated when it is not in operation.

**Note:** Oil-free (dry) pumps can operate with closed suction.





Oil-free (dry) pumps (RVD012L and up) are fitted with a built-in inlet filter. If the possibility exists that the inlet gas pumped contains dust or foreign particles, an additional 5 micron (or finer) inlet filter should be installed at the inlet port.

For more information consult the factory.

The following includes the inlet connection sizes for the different pump models:

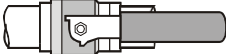
<b>Pump Model</b>	<b>Inlet Size</b>
RVD002L	3/8" hose
RVD004L	1/4" NPT
RVD007L	1/2" NPT
RVD012L	1/2" NPT
RVD018L	3/4" NPT
RVD028L	1" NPT
RVD040L	1" NPT
RVD060L	1" NPT
RVD075L	1 1/2" NPT

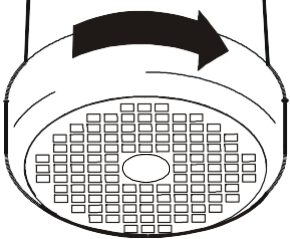
## **START-UP PROCEDURES**

1	Ensure all shipping plugs and/or paper covers are removed from system and tagging information is followed for successful startup.	
2	Check that the inlet valve is open.	
3	<p>Jog the motor briefly and check direction of rotation which is marked by an arrow on the end of the motor or pump housing. If the rotation is incorrect on a three phase motor, switch any two of the three main power leads. A loud grinding noise and absence of vacuum is an indication of improper motor direction.</p> <p style="text-align: center;"></p> <p><b>WARNING: OPERATING PUMP BACKWARD CAN CAUSE VANE FAILURE.</b></p>	
4	<p>Check the voltage and motor current. They should be within the specifications for the motor. Amperage should be checked at the Overload.</p> <p><b>Note:</b> This test should also be performed under normal system operating conditions.</p>	<p style="text-align: center;"></p> <p><b>DANGER: HIGH VOLTAGE!</b> Lethal shock hazard present. <b>USE EXTREME CAUTION!</b></p>
5	Remove temporary inlet screen.	

## **SHUT DOWN PROCEDURES**

To stop the vacuum pump follow the procedure as outlined below.

- Push the STOP button or turn switch to the OFF position.

## **MAINTENANCE**



**WARNING:** Before attempting any maintenance, disconnect all power from the system by switching off the main breaker, isolate all energy sources and allow system to cool.

### **Pump Bearing Lubrication**

Internal pump components do not require preventative maintenance. Bearings are self-lubricating type.

### **Motor Bearing Lubrication (where required)**

For information regarding motor bearing lubrication, refer to the motor maintenance and operation manual.

## Vanes

Check the vane width “A” after 4000 hours of operation. The difference between the measured value (mm) and the minimum value shown in the table below represents the residual life of the vanes in operational hours. Before replacing the vane consider that 1 mm = approximately 1000 operational hours.

Minimum Vane Dimensions	
Pump model	Dimension A
RVD002L	14 mm
RVD004L	19 mm
RVD007L	27 mm
RVD012L	32 mm
RVD028L	33 mm
RVD040L	36 mm
RVD060L	36 mm
RVD075L	41 mm

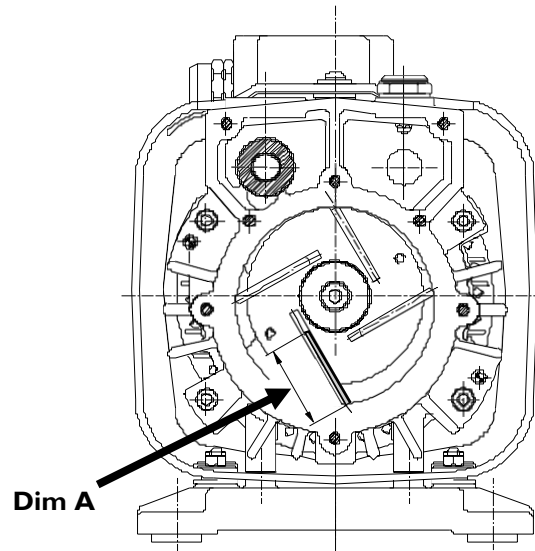

## MAINTENANCE SCHEDULE

To help ensure trouble free operation, a basic maintenance schedule consisting of the following system checks is recommended.

### First 8 Hours of Operation

- Check internal inlet filter element.
- Check external inlet filter, if installed.

### 500 Hours of Operation

- Under normal operating conditions repeat 8 hour check procedure as described above.

### 1000 Hours of Operation

- Clean or replace inlet filter element.
- Remove debris from pump housing, motor fan guard and heat exchanger.

### 2500 Hours of Operation

- Replace internal inlet filter cartridge.

### 4000 Hours of Operation

- Check vane width, see Vanes section above.

### 6000 Hours of Operation

- Replace vanes.

### 10,000 Hours of Operation

- Check coupling element for wear, if applicable. Replace if worn.
- Clean strainer in seal fluid line.
- Check belt tension, if applicable.

## 30,000 Hours of Operation

- Every 30,000 hours, or every 5 years, it is recommended that you replace the vacuum pump's shaft seals and bearings as preventative maintenance. This should be done by a DEKKER authorized distributor or properly trained service technician.

## ACCESSORIES (IF INCLUDED)

The following accessories are available for DuraVane rotary vane vacuum pump systems:

- **Flexible Connectors (optional):** Flex connectors are used in piping systems to eliminate vibration transmission from machinery throughout the piping network. If ordered, DEKKER uses braided flexible connectors on the DuraVane rotary vane vacuum pump.
- **Vibration Isolators (optional):** Vibration isolators are used to eliminate vibrations, noise and shock transmission from machinery to the floor. Floor-mount type vibration isolators are used for rotary vane vacuum pump systems.
- **Inlet Isolation Valve (optional):** The inlet isolation valve may be installed on the vacuum receiver tank or vacuum pump manifold. Usually the valve is used to isolate the vacuum pump from the piping network.
- **External Inlet Filter (optional):** An external inlet filter is optional but recommended and needs to be installed in the inlet piping.

## TROUBLESHOOTING

The following is a basic troubleshooting guide and not all options may be included. Service should be done by a DEKKER authorized distributor or a properly trained service technician. Each unit is tested and checked at the factory. Always indicate model and serial number when calling. The model and serial number is viewable on the gold-colored information plate attached to the unit.



**WARNING:** Before attempting any maintenance such as changing the fluid, disconnect all power from the unit by switching off the main breaker, isolate all energy sources and allow unit to cool. All electrical work should be done by a qualified electrician in compliance with OSHA, National Electric Code and any other applicable local electrical code.

## Start-Stop Problems

### *Unit will not start*

1. Check if the disconnect or circuit breaker is switched on.
2. Check reset button on control panel. Overloads may have been triggered.
3. Check setting of HOA switch and vacuum switches.
4. Check power. Make sure that supply voltage matches motor voltage.
5. To check electrical control panel disconnect power. Make sure that all wires are tight. Wires may vibrate loose during shipment or operation.
6. Check motor overload in control panel. Overload settings may be too low. Set overload setting in motor starter in accordance with the motor nameplate data (include Service Factor).
7. Check fuses in control panel.
8. Check motor wires. Motor may be wired incorrectly. Look at motor wiring diagram on conduit box of motor for correct wiring configurations. Make sure connections are secure.
9. Check wire size and length. Incorrectly sized wires can cause a voltage drop at the motor.
10. Pump or motor may be seized. Contact the factory.

### ***Unit starts, but has difficulty doing so, and draws a high current***

1. Stop unit and disconnect power.
2. Check motor wires. Motor may be wired incorrectly. Look at motor wiring diagram on conduit box of motor for correct wiring configurations. Make sure connections are secure.
3. Check if motor rotation is correct by comparing it to the arrow on the motor or pump housing. If incorrect switch any two of the three main power leads on the contactor inside the control panel (3-phase only).
4. Check power supply. Excessively high or low voltage or phase imbalance will damage motor.
5. Foreign particles may have carried over into pump causing damage to the vanes or other internal parts. Contact the factory.
6. Unit may have seized due to high temperature operation. Contact the factory.

## **Vacuum Problems**

### ***Unit is not drawing vacuum***

1. Stop unit and disconnect power.
2. Check if the motor rotation is correct. Rotation is marked by an arrow on the motor or pump housing. If incorrect, switch any two of the three main power leads on the contactor inside the control panel.
3. Check vacuum gauge. Gauge may be faulty. Replace.
4. Check if the inlet valve is open and inlet filter is clean.
5. Ensure that no lines are open to the atmosphere, causing loss of vacuum.
6. Check for leaks in piping systems, using conventional leak detection methods.
7. Check internal pump filter cartridge (RVD012L and up), clean or replace.
8. Check to see if inlet check valve assembly is stuck in closed position due to contamination. Disassemble and clean inlet check valve and screen as required.
9. Internal parts may be worn or damaged. Contact the factory.
10. One or more of the vanes in the rotor may be stuck. Contact the factory.

### ***Unit is not reaching ultimate vacuum level***

1. Stop unit and disconnect power.
2. Check vacuum gauge. Gauge may be faulty. Replace.
3. Check to see if system is holding vacuum. This can be done by shutting the unit down and observing for about 30 minutes if the gauge on the receiver or pipe system is holding. If vacuum is not holding, check all pipe connections for leaks using conventional leak detection methods.
4. Check internal pump filter cartridge (RVD012L and up), clean or replace.
5. Check to see if inlet check valve assembly is stuck in closed position due to contamination. Disassemble and clean inlet check valve and screen as required.
6. Internal parts may be worn or damaged. Contact the factory.
7. Check pump model and specifications. Pump may not be suitable for application. Contact the factory.

## **Overheating Problems**

### ***Unit is overheating***

1. Stop unit and disconnect power.
2. Make sure that pump is being cooled correctly. Check that pump is located in a well-ventilated area. Maximum ambient temperature for the rotary vane vacuum pumps is 104°F.
3. Inspect fan for damage.
4. Clean motor and pump air grills if needed.
5. Check internal inlet filter cartridge (RVD012L and up), clean or replace.

## **Noise and Vibration Problems**

### ***The unit is making an abnormal noise or sound***

1. Foreign particles may have carried over into the pump, causing damage to the vanes or other internal parts.
2. Check bearings. If bearings are noisy, contact the factory for replacement instructions.
3. One or more of the vanes in the rotor may be stuck. Contact the factory.

## Troubleshooting Quick Reference Guide

Issue	Cause	Remedy
<b>Start Stop Issue</b>	No main AC power in panel	Confirm disconnect is on and fuses are good
	No 24VDC power in panel	Check fuse and bottom connection
	Overload is not set correctly	Set according to motor data FLA X SF
	Alarm overload is tripped	Reset overload
	Loose wires	Check all incoming and panel wires
	Low level switch is engaged	Add fluid if necessary
	Pump has seized	Check shaft spin by hand at coupling, if froze, contact factory
	Vacuum Set points are not set properly	Set according to Controller Manual
	Main Breaker trips immediately upon start up	Check motor connection/windings Pump is flooded
<b>Low Vacuum</b>	Inlet Valve is closed	Open valve
	Lines or process is open to atmosphere	Seal all open areas
	Leaks in piping	Check and correct piping leaks
	Pump is not primed	Check pump to ensure it has oil to create the liquid ring
	Fluid Supply valve is closed	Open valve, and check pump for prime
	Motor rotation is backward	Check and change rotation as needed
	Inlet filter element is clogged with contamination	Clean or change filter element
	Vacuum set points are not set properly	Set according to Controller Manual
	Solenoid valve not working	Check wires, voltage to coil, or obstruction from contamination
Vacuum relief valve fail	Check valve for adjustment or replace	
<b>Overheating</b>	Radiator fins are clogged	Check and clean debris in fins
	Radiator is blocked internally	Check temperature drop across cooler when running, should be 25 F delta
	Loss of fluid flow	Check and clean y-strainer screen
		Check if fluid supply valve is open Check if solenoid valve is functioning
	Thermostat valve (if installed) is not opening	Replace element
Running at low vacuum levels	Operate system at no less than 15" HgV	
<b>Noise and Vibration</b>	Coupling is misaligned or broken	Align and change element as needed
	Check bearings in motor and pump	Rotate coupling by hand, if rubbing or binding, call factory
	Pump hydraulic noise at deep vacuum	Pump is cavitating, open inlet to allow some air in
	System baseplate is not secure	System should be on level surface and supported
	Mounting bolts or piping is loose	Check all bolts on system, and secure piping
<b>Oil Mist or Carryover</b>	Running at low vacuum levels	Operate system at no less than 15" HgV
	Exhaust separator element needs service	Check back pressure, change filter as needed
	Scavenge line on tank and separator has blockage	Clean lines and ports as needed
	Excessive water carried over from process	Remove all excess water from separator tank at drain
<b>Mechanical Seal Leaks</b>		Change fluid
	Contamination in fluid	Change inlet filter
	Pump was ran without fluid	Change seal, ensure fluid supply lines are open, and pump is primed